

PRORIL

50 Hz

Designed for continuous operations, excellent performance and easy maintenance, PRORIL Tank series pumps have proven their reliability and durability in demanding areas like construction, mining, tunneling, quarries, industries and rental applications.

Dewatering Pump

TANK 222

High Chrome Dewatering Pump



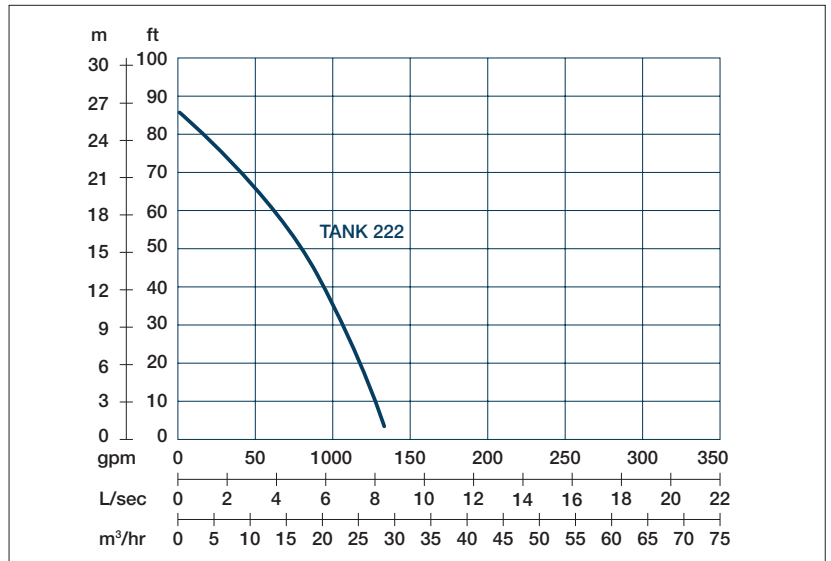

Shaft Speed : 2850 rpm

Outlet : 50mm, 2in

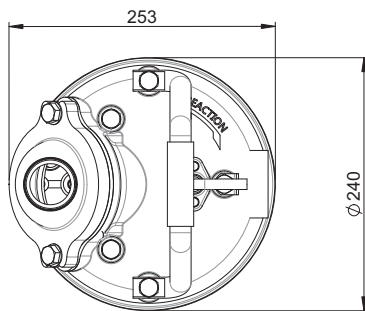

OUTPUT	HEAD	FLOW
2.2 kW	Rated : 15m, 49ft	Rated : 5 l/s, 79 gpm
3 HP	Max : 26m, 85ft	Max : 8 l/s, 132 gpm

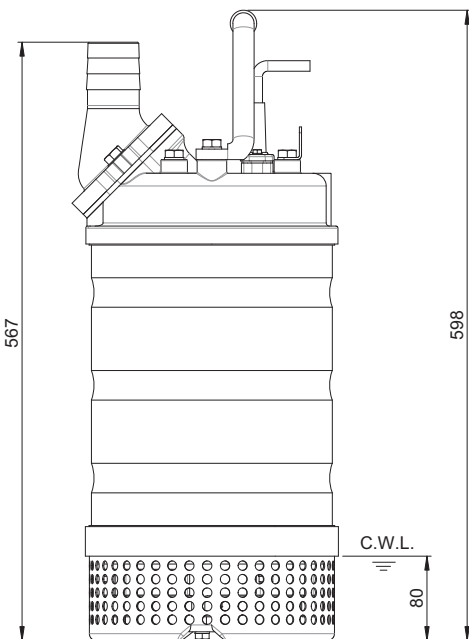

Weight : 35kg / 77 lbs

Pump Type	Electric Submersible Pumps	
	3-Phase	
Motor	Type	Induction Motor
	Poles	2 Pole
	Insulation	Class F
	Protector	Circle Thermal Protector
	Starter	D.O.L.
Lubricant	Food Grade (ISO VG32)	
Impeller Type	Opened	
Shaft Seal	Double Mechanical Seal	
	Silicon Carbide VS Ceramic / Carbon	
Bearings	C3 Shielded ball bearings	
Cable	H07BQF	
	Length: 20m (66ft) or longer upon request.	
Materials	Pump Casing	Gray Iron
	Impeller	Chromium Iron
	Motor Frame	Stainless Steel
	Motor Shaft	Stainless Steel
	Strainer	Stainless Steel
Max. Liquid Temperature	104°F (40°C)	
Max. Submersion Depth	66ft (20m)	
pH Range	pH 5 - pH 8	